

جهت تهیه فایل ورد این مقاله به سایت DaneshResan.com مراجعه نمایید و عنوان مقاله را جستجو کنید
بیش از ۲ میلیون مقاله فارسی در این سایت موجود میباشد

()

استفاده از شبکه عصبی مصنوعی در پیشگویی نیروی نورد فولاد

Use of Artificial Neural Network in Predicting the Steel Roll-force

S. Iranpour

Department of Computer Engineering
University of Science and Technology

Abstract

The aim of the present work is to study the effect of chemical compound of the steel roll on the force required for rolling in the roll gap. This force is known as "roll force". Mathematical models for calculation of the rolling force merely include parameters for which an exact relation with the roll force is known. Since there is no clear mathematical relation between the chemical compound elements of the plate and the roll force in most of mathematical models, these parameters are not considered. However, in some models these parameters are used as an empirical coefficient. Hence the output of mathematical models contain some error due to these unknown parameters.

In this paper, the capability of the neural network in predicting the roll force was examined. The chemical compound of the plate in predicting the roll force without considering any mathematical relation with the roll force was used.

Keywords: Rolling, Roll force, Roll gap

()

/...

(.) Mizushima

:

(.)

:

$$F_m = (W, H, R, T_e, V, \mu, \dots)$$

:W

:F_m

/

:R	:H
:V	:Te
	:μ

/

/

/...

.()

B A

/

:

	H R Te W T V	A
	C, Si, Mn, PS, Cr, V, Cu, Al, Ti, Mo, Ni, As, B, Sn	B

tanh

%

/

%

/

/...

$$\alpha_M \quad \alpha_N \quad w_M \quad w_N \quad \alpha = w_M \cdot \alpha_M + w_N \cdot \alpha_N$$

$$w_N = /$$

$$\alpha_M$$

$$\alpha \quad w_M = /$$

$$\alpha$$

$$w_M = / \quad w_N = /$$

%

- . H. F. Bozenhardt, "Artificial Intelligent improves quality in steelmaking, Iron and Steel Eng., June , pp. .
- Υ. Y. Z. Lu., "Meeting the challenge of intelligent system technologies in the iron and steel industry", Iron and Steel Eng., September 1996, pp 139-148.
- Υ. G. Bloch, "Neural intelligent control for a steel plant", IEEE Transaction on neural network, vol 8, no. 49, 1997, pp 910-917.
- ξ. Y. Z. Lu., "Application of Neural Network Technology in the Metal Industry", AISE 3rd Advanced Modeling and control Seminar, September 1994.
- ο. N. Portman, "Application of neural networks in rolling mill automation", Iron and Steel Eng., vol 72, no 2, pp. 33-36.

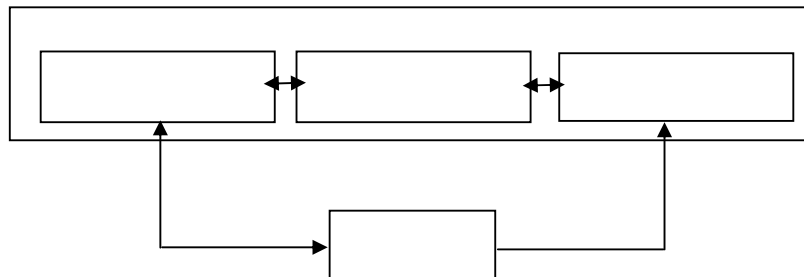

/...

:

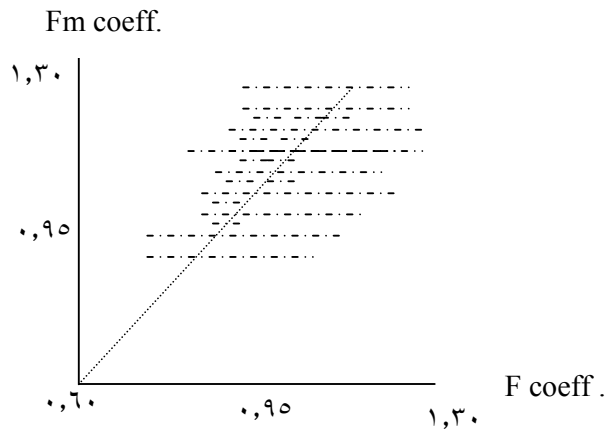

:

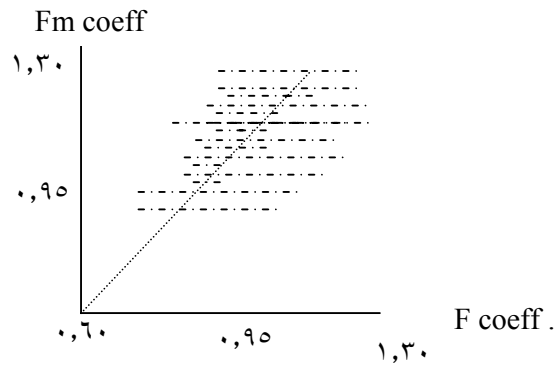

:

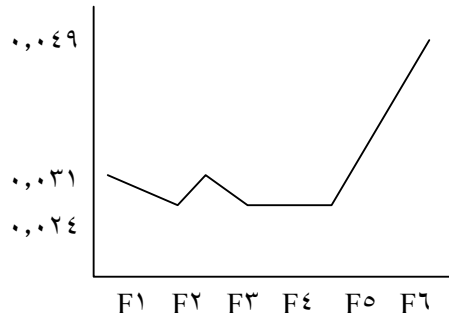

/

:

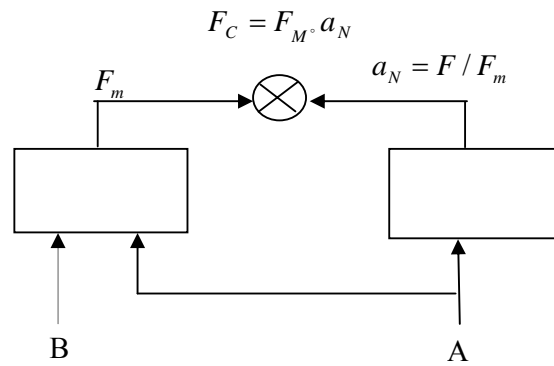

:

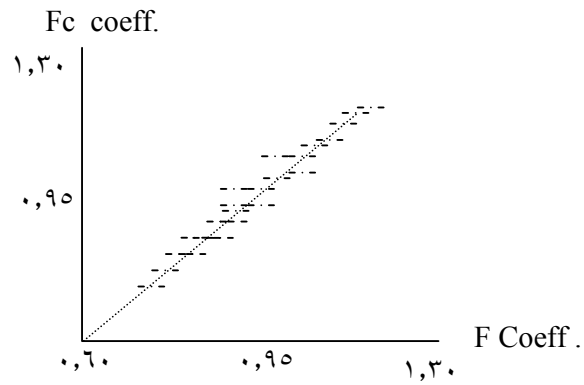

:

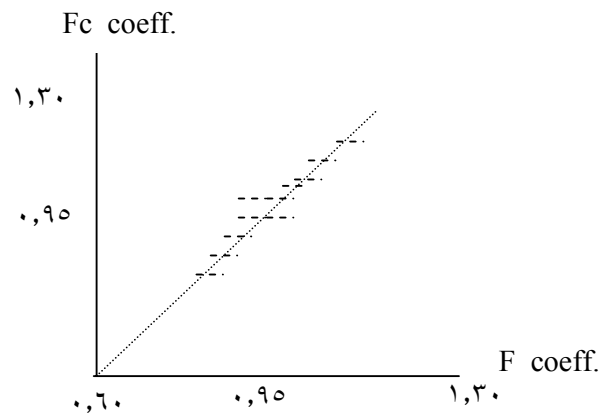

/...

, :

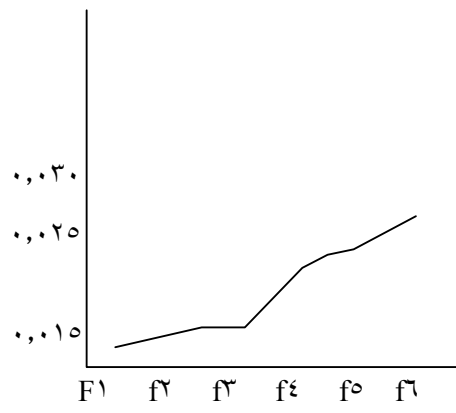

: