

()

شکست در هستک‌های ساکارومایسز سرویزیا

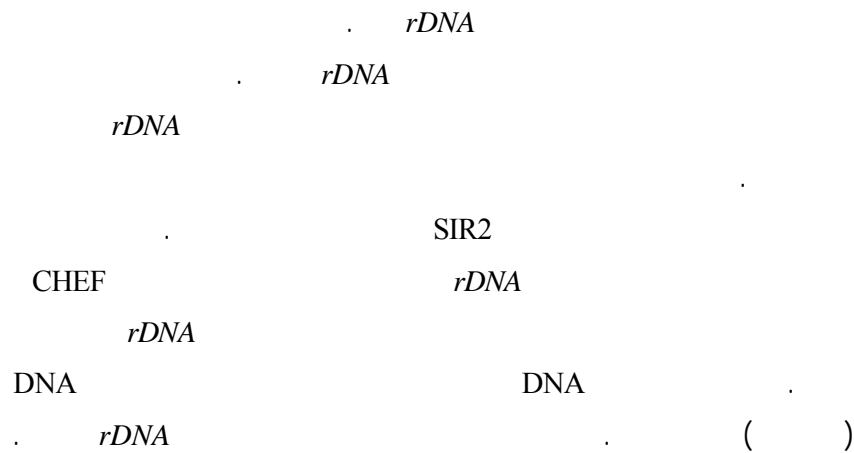

(DSB) CHEF : *rDNA*

Breaks in the Nucleous of *Saccharomyce Cerevisiae*

M. Motovali-Bashi and Z. Hojati

Department of Biology, University of Isfahan

Abstract

The eukaryotic cells have one or more nucleolus in the nucleus. *Saccharomyces Cerevisiae* has a crescent nucleolus close to the nuclear envelope into which part of chromosome XII including repeated units of the rDNA genes is transported into crescent nucleolus of yeast. Studies on the recombination at this region show some crossing over between sister chromatid of chromosome XII. However, non-sister chromatid exchange of homologous chromosome XII is not observed at the rDNA region, suggesting in suppression of double-strand breaks (DSBs) at that region. It has been suggested that silencing proteins including Sir2 have important role in silencing state of chromatin for recombination. We studied the occurrence of DSBs at the rDNA region using pulse field gel electrophoresis via CHEF technique and restriction enzymes which can not cut within the rDNA unit. DSB's fragments were detected using an specific rDNA probe in Southern blot technique. Despite previous suggestions, results show some breaks in the nucleolus, which can not be detected using recombination techniques. This suggests that ultra-structure of

/

chromatin in the nucleolus is completely different compared to that of the nucleus.

Keywords: *Saccharomyces Cerevisiae*, Pulse field gel electrophoresis (CHEF), Nucleolus, Double-strand breaks (DSB), rDNA gene

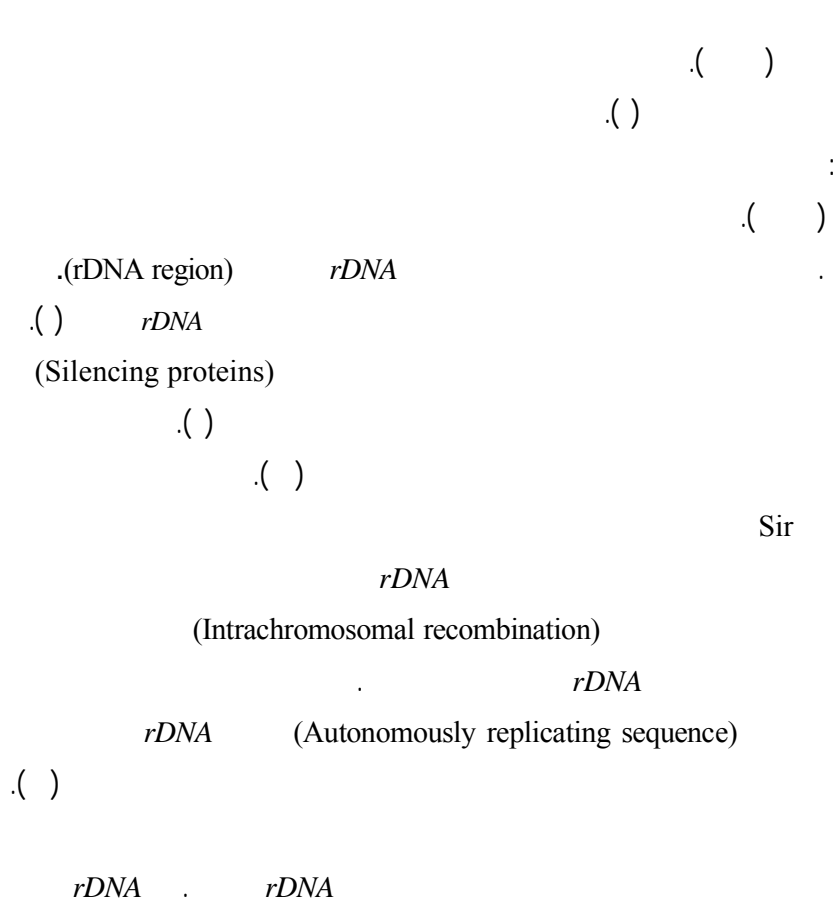

(Extrachromosomal rDNA Circle; ERC) rDNA

/

()

(Unequal sister chromatid exchange)

()

rDNA

rDNA

rDNA

rad50S

rDNA

rad50

(Double-strand Break; DSB)

3'

5'

()

(DSB recombination repair)

(Southern Blot)

CHEF

rDNA

(DNA recombination hot spot region)

CHEF (Pulse field gel electrophoresis)

(contour-clamped homogenous electric field)

rDNA

()

rDNA

()

rDNA

/

.(;)

rDNA

)

ORD1181

.(

UMIST

rad50

DNA

YEPD

.()

(*rad50S*) ORD1181

.()

()

DNA

(Southern Blot)

.()

(probe)

rDNA

(random primer kit)

ORD1181

CHEF

DNA

DNA

/

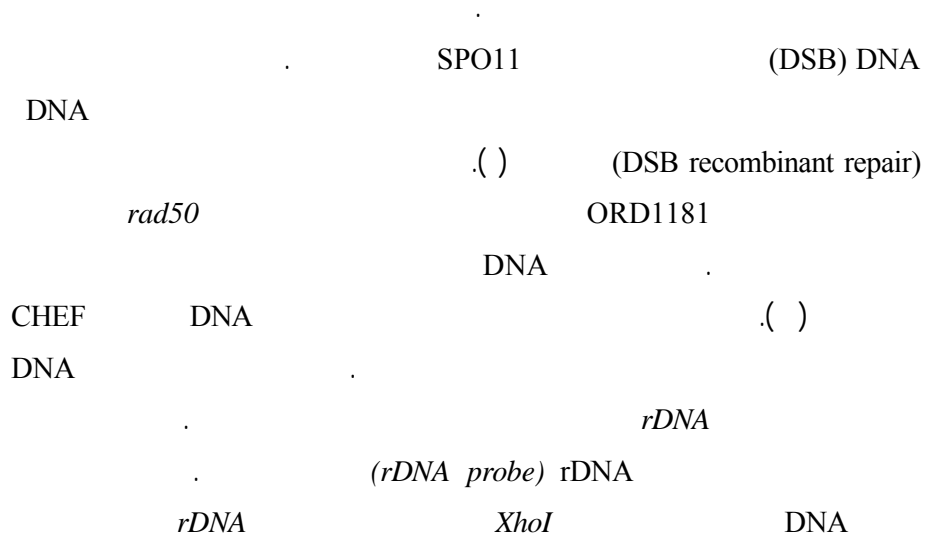

() ()

rDNA

/

.()

(USCE)

rDNA

.()

(ORD1181) *rad50S*

(USCE)

.()

.() (DSB)

.()

rDNA

() *rDNA*

)

(DSB)

.(

.(

(II)

SPO11

)

.()

rad50S

DNA

DSB

DNA

rDNA

Guarente Sinclair

.()

rDNA

Sir2 (Silencing proteins)

() *rDNA*
rDNA

(Intrachromosomal recombination)

(Interchromosomal recombination) ERC

1. Chu, G., Vollrath, D. and Davis, R. 1986. Separation of large DNA molecules by contour clamped homogeneous electric fields. *Science*, 234, pp. 1582-1585.
2. Jazwinski, S. 1996. Longevity, genes, and ageing. *Science*, 273, pp. 54-59.
3. Keeney, S., Giroux, C and Kleckner, N. 1997. Meiosis specific DNA double strand breaks are catalysed by spo11, a member of a widely conserved protein family. *Cell*, 88, pp. 375-384.
4. Kennedy, B., Austriaco, N and Guarente, L. 1994. Daughter cells of *Saccharomyces cerevisiae* from old mothers display a reduced life span. *J Cell Biol*, 127, pp. 1985-1993.
5. Kennedy, B., Austriaco, N, Zhang, J. and Guarente, L. 1995. Mutation in the silencing gene SIR4 can delay ageing in *S. cerevisiae*. *Cell*, 80, pp. 485-496.
6. Kennedy, B., Gotta, M. Sinclair, D., Mills, K. McNabb, D. Murthy, M.; Pak, SM. Laroche, T. Gasser, SM and Guarente, L. 1997. Redistribution of

- silencing protein from telomeres to the nucleolus is associated with extension of life span in *S. cerevisiae*. *Cell*, 89, pp. 381-391.
7. Mizuno, K., Emura, Y., Baur, M., Kohli, J., Ohta, K. and Shibata, T. 1997. The meiotic recombination hot spot created by the single-base substitution ade6-M26 results in remodelling of chromatin structure in fission yeast. *Genes Dev*, 11, pp. 876-886.
 8. Motovali-Bashi M., Hojati Z. and Walmsley R. 2003. Initiation of ageing process by meiotic and mitotic recombination in *Saccharomyces cerevisiae*. *IJB*, 1 (4), pp. 218-223.
 9. Motovali-Bashi M., Hojati Z. and Walmsley R. 2004. Unequal sister chromatid exchange within the rDNA genes in *Saccharomyces cerevisiae*. Mutation Research, Genetic Toxicology and Environmental Mutagenesis, In press.
 10. Pasero, P. and Marilley, M. 1993. Size variation of the rDNA clusters in the yeast *Saccharomyces cerevisiae* and *Schizosaccharomyces pombe*. *Mol Gen Genet*, 236 (2-3), pp. 448-452.
 11. Petes, T. 1980. Unequal meiotic recombinant within tandem arrays of yeast ribosomal DNA genes. *Cell*. 19 (3), pp. 765-774.
 12. Petes, T. 1979a. Meiotic mapping of yeast ribosomal DNA on chromosome XII. *J Bacteriol*, 138, pp. 185-192.
 13. Pohley, H. 1987. A formal mortality analysis for populations of nucleolar organisms (*Saccharomyces cerevisiae*). *Mechanisms of Ageing and Development*, 38, pp. 231-243.
 14. Rustchenko, E. and Sherman, F. 1994. Physical Constitution of Ribosomal genes in common strains of *Saccharomyces cerevisiae*. *Yeast*, 10, pp. 1157-1171.
 15. Sinclair, D., and Guarente, L. 1997. Extrachromosomal rDNA circles a cause of ageing in yeast. *Cell*, 91, pp. 1033-1042.
 16. Sinclair, D., Mills, K. and Guarente, L. 1997. Accelerated ageing and nucleolar fragmentation on yeast *sgs1* mutants. *Sciences*, 277, pp. 1313-1319.
 17. Smeal, T., Claus, J., Kennedy, B., Cole, F. and Guarente, L. 1996. Loss of transcriptional silencing causes sterility in old mother cells of *S. cerevisiae*. *Cell*, 84 (4), pp. 633-642.
 18. Smith, K. and Nicolas, A. 1998. Recombination at work for meiosis. *Curr Opin in Genet Dev*, 8, pp. 200-211.
 19. Sun, H., Treco, D. and Szostak, J. 1991. Extensive 3'-overhanging, single-stranded DNA associated with the meiosis-specific double-strand breaks at the ARG4 recombination initiation site. *Cell*, 64, pp.1155-1161.
 20. Szostak, J. and W. R. 1980. Unequal crossing-over in the ribosomal DNA of *Saccharomyces cerevisiae*. *Nature*, 284 (5755), pp. 426-430.

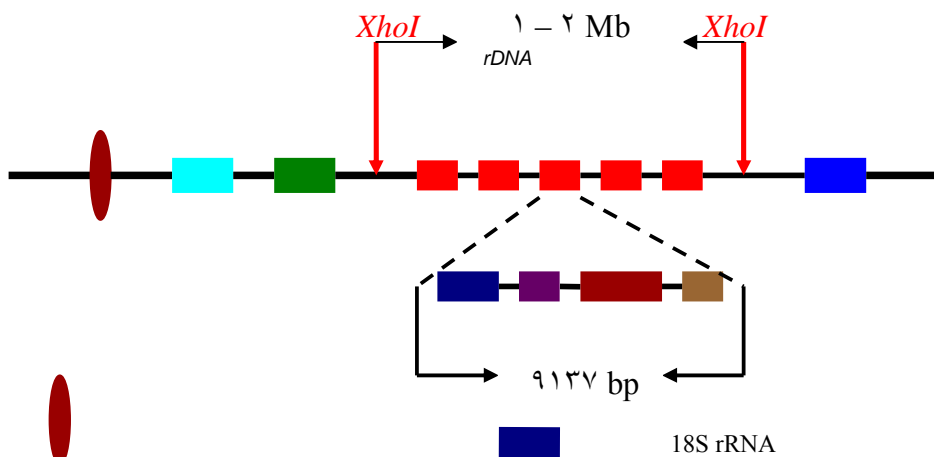

/

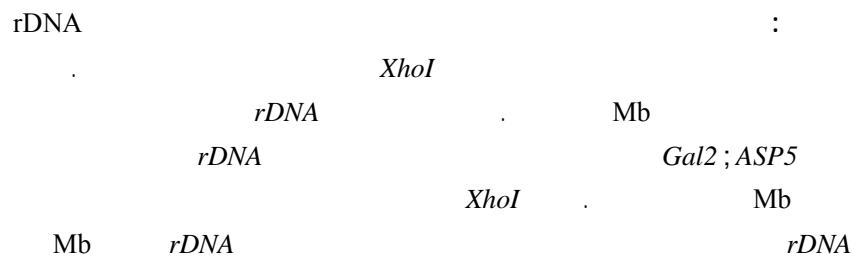

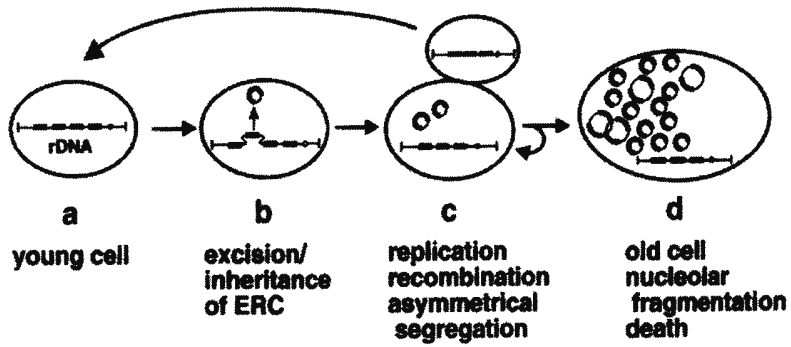

Cell, 91, pp.

Sinclair Guarente

:

.1033-1042)

(ERCs) *rDNA*

DSB

(Intrachromosomal recombination)

ARS

/

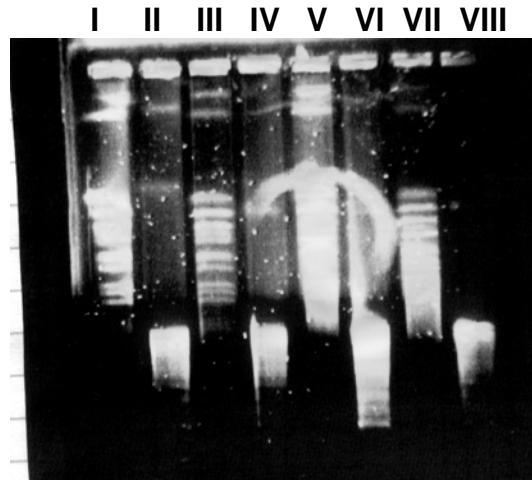

DNA :
. CHEF

- . I
- . *XhoI* . II
- . III
- . *XhoI* . IV
- . V
- . *XhoI* . VI
- . II
- . VII
- . *XhoI* . VIII

/

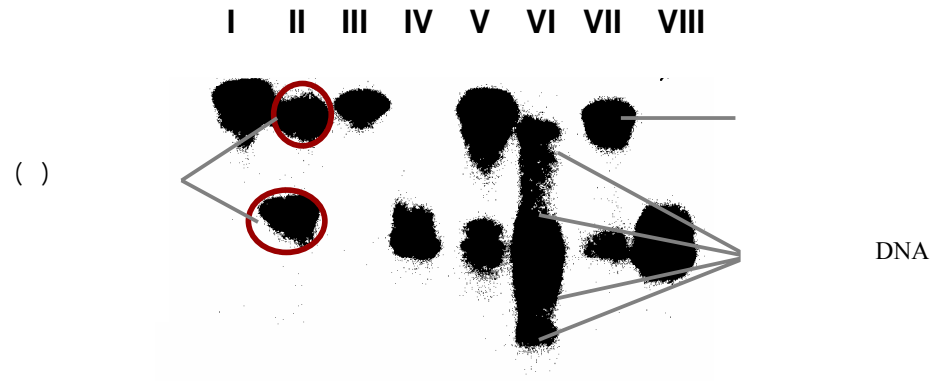

rDNA

() CHEF :

		.I
	<i>XhoI</i>	.II
		.III
	<i>XhoI</i>	.IV
.I		.V
	<i>XhoI</i>	.VI
		II
		.VII
(rDNA)	
IV	<i>XhoI</i>	.VIII