

SMA

SMA

(SMA)

## *Effects Of SMA Wires Free Vibration Of Shape Memory Sandwich Panel*

A.mozaffari; M.Karami and A.H.Azarnia

### **ABSTRACT**

Shape memory alloys(SMA) due to the exhibition of certain performance such as high damping, shape memory effects and Super-elasticity are consider for application in engineering systems.

In this study, considering the usage of composite-sandwich structures in various industries including aerospace, the effects of SMA parameters such as SMA volume fraction and SMA wires temperature on hybrid sandwich panel free vibrations with transverse flexible core have been surveyed. The SMA wires (NiTiNol) are embedded at the mid-plane of the sandwich face sheets. For analyze, the improved high order theory is applied, First Shear Deformation Theory (FSDT) at the composite face sheets and Elasticity Theory by the assumption of inertia forces at the core. For governing equations of simply support panel Hamiltonian method has been used. At this study it is assumed that the SMA recovery stress produced via temperature actuation is exerted tensely on mid-plane of the face sheets. For solving problem and simplification the Galerkin method is used. The results showed that SMA actuation improves the vibration behaviors of whole sandwich panel.

**KEYWORDS** : Sandwich panel- shape memory alloy- Hamilton principle- Improved high order theory- FSDT

/// :  
/// :

mozaffari@kntu.ac.ir

mohammadkarami61@gmail.com

azarnia@gmail.com

i

ii

iii

SMA

- )

(

SMA

SMA

[ ]

( )

SMA

SMA

SMA

SMA

SMA

( )

[ ]

SMA

SMA

SMA



SMA

( ) ( )

SMA

[ ]

$$u_i(x, y, z, t) = u_{0j}(x, y, t) + z\psi_{xj} \quad ( )$$

$$v_i(x, y, z, t) = v_{0j}(x, y, t) + z\psi_{yj} \quad \text{SMA}$$

$$w_i(x, y, z, t) = w_{0j}(x, y, t)$$

$w_{0j}, v_{0j}, u_{0j}$

$\psi_{yj}, \psi_{xj}$

(  $j = t, b$  )

SMA

[ ]

$$\begin{cases} \varepsilon_{xj} \\ \varepsilon_{yj} \\ \gamma_{xyj} \end{cases} = \begin{cases} u_{0j,x} \\ v_{0j,y} \\ u_{0j,y} + v_{0j,x} \end{cases} + z \begin{cases} \psi_{xj,x} \\ \psi_{yj,y} \\ \psi_{xj,y} + \psi_{yj,x} \end{cases} \quad ( )$$

[ ]

SMA

$$\begin{cases} \gamma_{yz} \\ \gamma_{xz} \end{cases} = \begin{cases} w_{0,x} + \psi_x \\ w_{0,y} + \psi_y \end{cases} \quad ( )$$

( )

[ ]

$$\int_{t_1}^{t_2} \delta(U + V - T) dt = 0 \quad ( )$$

$U, V, T$

[ ]

SMA

$\delta$

$t$

$t_2 - t_1$

[ ]

:

$t_2, t_1$

SMA

$$\delta T = - \int_{t_1}^{t_2} \left\{ \sum_{j=t,b,c} \int_{V_j} \rho_j [\ddot{u}_j \delta u_j + \ddot{v}_j \delta v_j + \ddot{w}_j \delta w_j] dV_j \right\} dt \quad ( )$$

[ ]

SMA

$\ddot{w}, \ddot{v}, \ddot{u}$

$w, v, u$

$j = t, b, c \quad z, y, x$

SMA

[ ]

:

[ ]

$$\delta U = - \int_{t_1}^{t_2} \int_{V_j} [\sigma_{xx}^j \delta \varepsilon_{xx}^j + \sigma_{yy}^j \delta \varepsilon_{yy}^j + \tau_{xy}^j \delta \gamma_{xy}^j + \tau_{xz}^j \delta \gamma_{xz}^j + \tau_{yz}^j \delta \gamma_{yz}^j] dV dt \quad [ ] [ ]$$

$$+ \int_{t_1}^{t_2} \int_{V_c} [\tau_{xz}^c \delta \gamma_{xz}^c + \tau_{yz}^c \delta \gamma_{yz}^c + \sigma_{zz}^c \delta \varepsilon_{zz}^c] dV dt \quad ( )$$

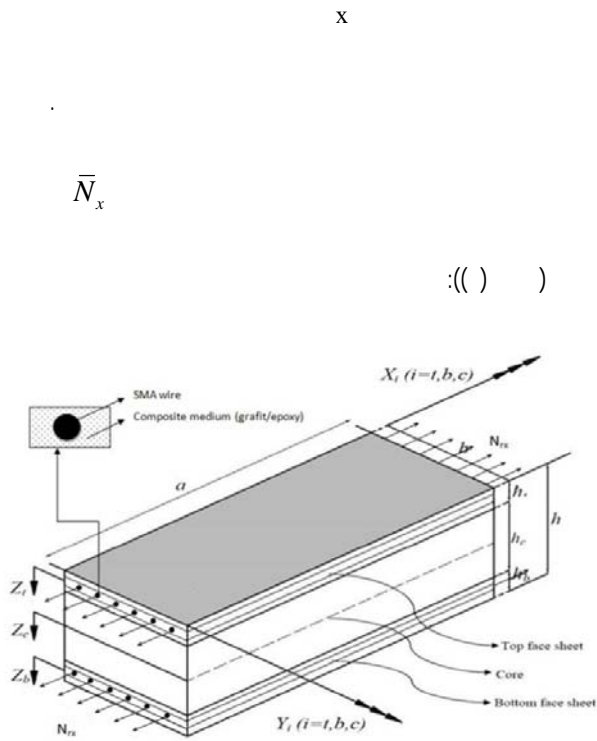

$$\begin{matrix} \varepsilon_{ii} & \sigma_{ii} \\ \gamma_{iz} & \tau_{iz} \end{matrix} \quad (i=x, y)$$

$$\bar{N}_x \quad \varepsilon_{zz}^c \quad \sigma_{zz}^c$$

$$V_b \quad V_t \quad V_{core}$$

$$\begin{bmatrix} \gamma_{xz}^c \\ \gamma_{yz}^c \\ \varepsilon_{zz}^c \end{bmatrix} = \begin{bmatrix} u_{c,z} + w_{c,x} \\ v_{c,z} + w_{c,y} \\ w_{c,x} \end{bmatrix} \quad (1)$$

$$\delta V = - \int_V \left[ \bar{N}_{xi} \left( \frac{\partial^2 w_{0t}}{\partial x^2} \right) + \bar{N}_{yi} \left( \frac{\partial^2 w_{0t}}{\partial y^2} \right) + 2\bar{N}_{xyi} \left( \frac{\partial^2 w_{0t}}{\partial x \partial y} \right) \right] dV \delta w_{0i} \quad (N^r)$$

$$\ddot{u}_c(x, y, z_c, t) = (\ddot{u}_{0b} - \ddot{u}_{0t}) \left( \frac{z_c}{c} \right) + \ddot{u}_{0t} \quad (2)$$

$$\ddot{v}_c(x, y, z_c, t) = (\ddot{v}_{0b} - \ddot{v}_{0t}) \left( \frac{z_c}{c} \right) + \ddot{v}_{0t}$$

$$\ddot{w}_c(x, y, z_c, t) = (\ddot{w}_{0b} - \ddot{w}_{0t}) \left( \frac{z_c}{c} \right) + \ddot{w}_{0t}$$

$$N^r = \iint_{A_w} \sigma^r dA_w = \sigma^r h_s V \quad (j=x, y \quad i=t, b)$$

$$\tau_{xz,z}^c = \rho_c \ddot{u}_c, \tau_{yz,z}^c = \rho_c \ddot{v}_c \quad (3)$$

$$\tau_{xz,x}^c + \tau_{yz,y}^c + \sigma_{zz,z}^c = \rho_c \ddot{w}_c$$

$$:$$

$E_1$	$E_{1m}V_m + E_sV_s$
$E_2$	$E_{2m}E_s/E_{2m}V_s + E_sV_m$
$\nu_{12}$	$\nu_{12m}V_m + \nu_sV_s$
$\nu_{21}$	$\nu_{21m}V_m + \nu_sV_s$
$G_{12}$	$Q_{12} = G_{12m}G_s/(G_{12m}V_s - G_sV_m)$
$G_{23}$	$G_{23m}V_m + G_sV_s$
$V_m$	$1 - V_s$

$$E_s(t)$$

SMA

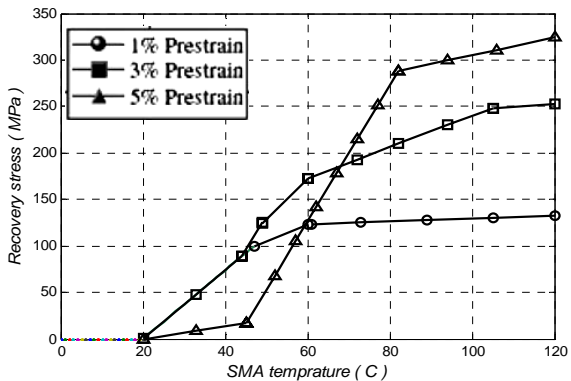

$$- \text{ SMA } \sigma^r :$$

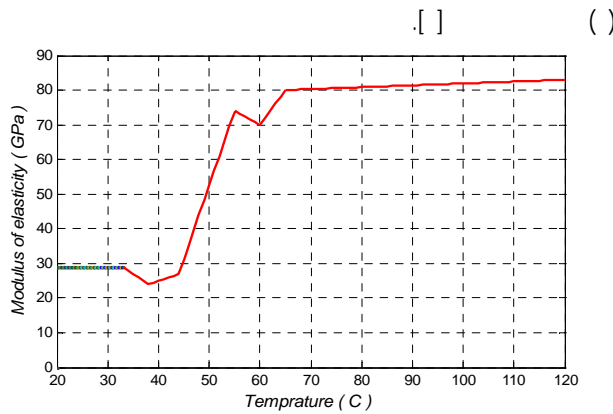

SMA

$$:$$

(SMA)

$$: [ ] [ ]$$

$$\begin{Bmatrix} \sigma_1 \\ \sigma_2 \\ \tau_{12} \end{Bmatrix} = \begin{bmatrix} Q_{11} & Q_{12} & 0 \\ Q_{21} & Q_{22} & 0 \\ 0 & 0 & Q_{66} \end{bmatrix} \begin{Bmatrix} \varepsilon_1 \\ \varepsilon_2 \\ \gamma_{12} \end{Bmatrix} + V_s \begin{Bmatrix} \sigma_1^r \\ 0 \\ 0 \end{Bmatrix}$$

$$\begin{Bmatrix} \tau_{yz} \\ \tau_{xz} \end{Bmatrix} = \begin{bmatrix} \bar{Q}_{44} & \bar{Q}_{45} \\ \bar{Q}_{45} & \bar{Q}_{55} \end{bmatrix} \begin{Bmatrix} \gamma_{yz} \\ \gamma_{xz} \end{Bmatrix} \quad ( )$$

$$[ Q_{ij} ]$$

$$\begin{Bmatrix} N \\ M \end{Bmatrix} = \begin{bmatrix} A & B \\ B & D \end{bmatrix} \begin{Bmatrix} \varepsilon \\ \psi \end{Bmatrix} + \begin{Bmatrix} N^r \\ M^r \end{Bmatrix} \quad ( )$$

$$\begin{Bmatrix} Q_x \\ Q_y \end{Bmatrix} = \begin{bmatrix} KA_{45}(w_{0,y} + \psi_y) + KA_{55}(w_{0,x} + \psi_x) \\ KA_{44}(w_{0,y} + \psi_y) + KA_{45}(w_{0,x} + \psi_x) \end{bmatrix}$$

$$(A_{ij}, B_{ij}, D_{ij}) = \int_{-h/2}^{h/2} Q_{ij}^k(1, z, z^2) dz$$

$$M^r \quad N^r$$

SMA

$$B=M \quad r=0$$

$$Q \quad N$$

$$G, \nu, V, E$$

$$D \quad B \quad A$$

h

K

$$y \quad x$$

m s

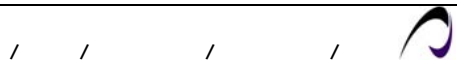

$$Q_y^j \quad Q_x^j$$

$$y \quad x$$

$$\rho_b \quad \rho_t \quad (j=t, b)$$

$$(\quad):$$

$$j=0,2 \quad I_{jb} = \int_{-h_b/2}^{h_b/2} \rho_b z^j dz \quad I_{jt} = \int_{-h_t/2}^{h_t/2} \rho_t z^j dz$$

SMA

$$KA_{45}^b (2w_{0b,xy} + \psi_{yb,x} + \psi_{xb,y}) + N^t w_{0b,xx} \quad (17)$$

$$+ KA_{44}^b (w_{0b,yy} + \psi_{yb,y}) + KA_{55}^b (w_{0b,xx} + \psi_{xb,x})$$

$$- (\tau_{xz,x}^c + \tau_{yz,y}^c) (c/2) + (w_{0t} - w_{0b}) \left( \frac{E_c}{c} \right)$$

$$+ \rho_c \{ \ddot{w}_{0b} (c/3) + \ddot{w}_{0t} (c/6) \} = I_{0b} \ddot{w}_{0b}$$

(SMA)

$$N_{xx,x}^t + N_{xy,y}^t + \tau_{xz}^c (z_c = 0) = I_{0t} \ddot{u}_{0t}$$

$$N_{yy,y}^t + N_{xy,x}^t + \tau_{yz}^c (z_c = 0) = I_{0t} \ddot{v}_{0t}$$

$$Q_{x,x}^t + Q_{y,y}^t + \bar{N}_{xt} + \sigma_{zz}^c (z_c = 0) = I_{0t} \ddot{w}_{0t}$$

$$N_{xx,x}^b + N_{xy,y}^b - \tau_{xz}^c (z_c = c) = I_{0b} \ddot{u}_{0b}$$

$$N_{yy,y}^b + N_{xy,x}^b - \tau_{yz}^c (z_c = c) = I_{0b} \ddot{v}_{0b}$$

$$Q_{x,x}^b + Q_{y,y}^b + \bar{N}_{xb} - \sigma_{zz}^c (z_c = c) = I_{0b} \ddot{w}_{0b} \quad (\quad)$$

$$M_{xx,x}^t + M_{xy,y}^t - Q_x^t + \tau_{xz}^c (z_c = 0) (h_t/2) = I_{2t} \ddot{\psi}_{xt}$$

$$M_{yy,y}^t + M_{xy,x}^t - Q_y^t + \tau_{yz}^c (z_c = 0) (h_t/2) = I_{2t} \ddot{\psi}_{yt}$$

$$M_{xx,x}^b + M_{xy,y}^b - Q_x^b - \tau_{xz}^c (z_c = c) (h_b/2) = I_{2b} \ddot{\psi}_{xb}$$

$$M_{yy,y}^b + M_{xy,x}^b - Q_y^b + \tau_{yz}^c (z_c = c) (h_b/2) = I_{2b} \ddot{\psi}_{yb}$$

( )

:[ ]

$$\begin{bmatrix} u_{0j}(x, y, t) \\ v_{0j}(x, y, t) \\ w_{0j}(x, y, t) \\ \psi_{xj}(x, y, t) \\ \psi_{yj}(x, y, t) \\ \tau_{xz}^c(x, y, t) \\ \tau_{yz}^c(x, y, t) \end{bmatrix} = \sum_{m=1}^{\infty} \sum_{n=1}^{\infty} \begin{bmatrix} u_{0jmn} \cos(\alpha_m x) \sin(\beta_n y) \\ v_{0jmn} \sin(\alpha_m x) \cos(\beta_n y) \\ w_{0jmn} \sin(\alpha_m x) \sin(\beta_n y) \\ A_{0jmn} \cos(\alpha_m x) \sin(\beta_n y) \\ B_{0jmn} \sin(\alpha_m x) \cos(\beta_n y) \\ T_{cxmn} \cos(\alpha_m x) \sin(\beta_n y) \\ T_{cymn} \sin(\alpha_m x) \cos(\beta_n y) \end{bmatrix} e^{-i\omega t}$$

$$\tau_{xz,z}^c = \rho_c \ddot{u}_c$$

$$\tau_{yz,z}^c = \rho_c \ddot{v}_c$$

$$\tau_{xz,x}^c + \tau_{yz,y}^c + \sigma_{zz}^c = \rho_c \ddot{w}_c$$

$w_c \quad w_{0b}, w_{0t}$

x

$u_c \quad v_{0b}, u_{0t}$

$$- (z_c = 0, z) \quad \sigma_{zz}^c \quad \tau_{yz}^c, \tau_{xz}^c$$

( )



SMA  
( )  
( )

x m,n  
j= t, b (rad/s) ω y

( ) ( )

( )

[ <sup>9</sup> •/•,SMA(•)/ <sup>9</sup> •/core/ <sup>9</sup> •/•,SMA(•)/ <sup>9</sup> •]			
a/b	h <sub>c</sub> /h	a/b	Ks
1.0	0.84	1	0.3
properties	graphit-epoxy	SMA	Core (foam)
E <sub>11</sub> (Gpa)	155	Es(t)	0.1135
E <sub>22</sub> (Gpa)	8.07	Es(t)	0.1135
E <sub>33</sub> (Gpa)	8.07	Es(t)	0.1135
G <sub>12</sub> (Gpa)	4/55	25/6	0.1886
G <sub>13</sub> (Gpa)	4/55	25/6	0.1886
G <sub>23</sub> (Gpa)	3/25	25/6	0.1886
ν <sub>12</sub>	0.22	0.3	0.32
ν <sub>13</sub>	.	.	.
ν <sub>23</sub>	.	.	.
ρ(kg/m <sup>3</sup> )	1586	645.	13.

$$KA_{45}^b (2\alpha_m \beta_n f_4 w_{0bmn} + \alpha_m f_4 B_{0bmn} + \beta_n f_4 A_{0bmn}) - KA_{44}^b (\beta_n^2 f_3 w_{0bmn} + \beta_n f_3 B_{0bmn}) - N^r \alpha_m^2 f_3 w_{0bmn}$$

$$-KA_{55}^b (\alpha_m^2 f_3 w_{0bmn} + \alpha_m f_3 A_{0bmn}) - (\alpha_m f_3 T_{cxmn} + \beta_n f_3 T_{cymn}) (c/2) + (f_3 w_{0mn} - f_3 w_{0bmn}) (E_c/c) - \omega^2 \rho_c f_3 (c/6) \{2w_{0bmn} + w_{0mn}\} = -I_{0b} \omega^2 f_3 w_{0bmn}$$

$$[k]_{10 \times 10} = [k_s]_{10 \times 10} + [k_r]_{10 \times 10} \quad ( )$$

$$[M] \{\ddot{\chi}\} + ([k_s] + [k_r]) \{\chi\} = \{0\} \quad ( )$$

$$\times \begin{matrix} [k_s] \\ [M] \\ [k_r] \end{matrix}$$

$$([k] - \omega^2 [M]) \{\chi\} = \{0\} \quad ( )$$

$$\lambda = (1/\omega^2) \quad K^{-1} M = A$$

$$|A - \lambda I| = 0 \quad ( )$$

h<sub>c</sub>/h = l

SMA

a/h = a/b = 0.70

( ) [ ]

SMA

[ ]

SMA

[ ]

( )

( )

[ ]

SMA

:( )

[ ]

[ /- / ,SMA( )/ / / ,SMA( )- / / ]

Ks=%

$\sigma^r$ $\approx$ (10 <sup>4</sup> psi)	Ref.[19]		Present work	
	1 <sup>st</sup> freq.	2 <sup>nd</sup> freq.	1 <sup>st</sup> freq.	2 <sup>nd</sup> freq.
	/	/	/	/
	/	/	/	/
	/	/	/	/
	/	/	/	/
	/	/	/	/
	/	/	/	/
	/	/	/	/

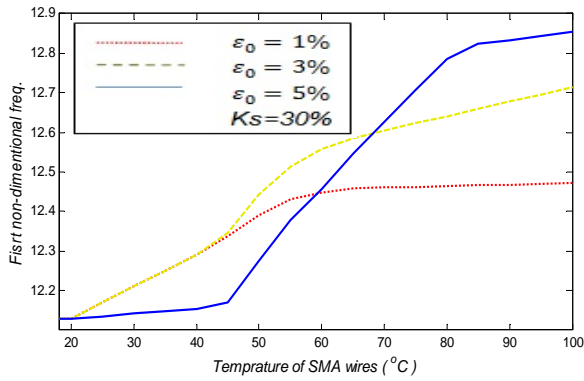

:( )

( )

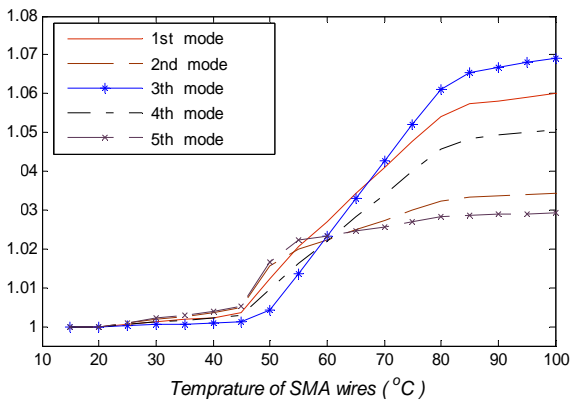

:( )

x

SMA

( )

( )

( )

SMA

SMA

( )

( b ) ( a )

$\omega_n$

$\bar{\omega}_n$

SMA

SMA

SMA

SMA

SMA

SMA

( $\omega_5$ )

( ) ( )

SMA

( $\omega_3$ )





SMA

( )

SMA

Ks

)

(SMA)

°C

%

°C

SMA

( )

%

SMA

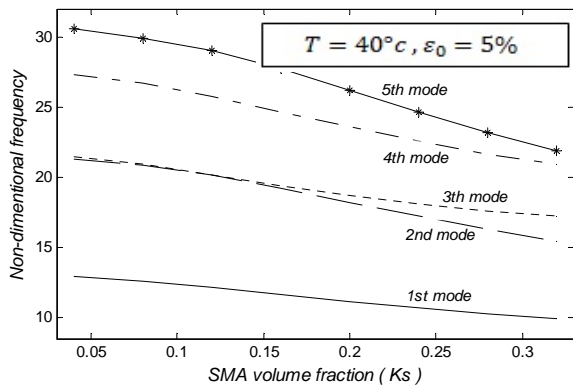

( )

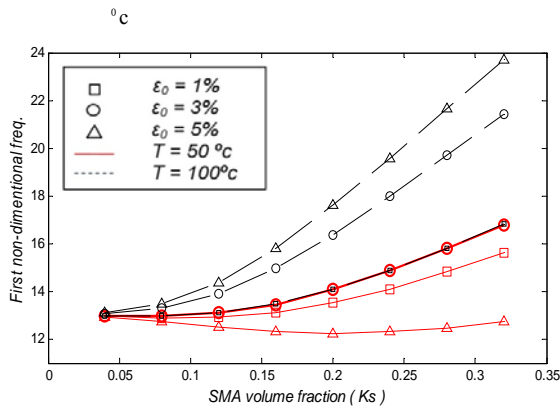

( )

( b ) ( a )

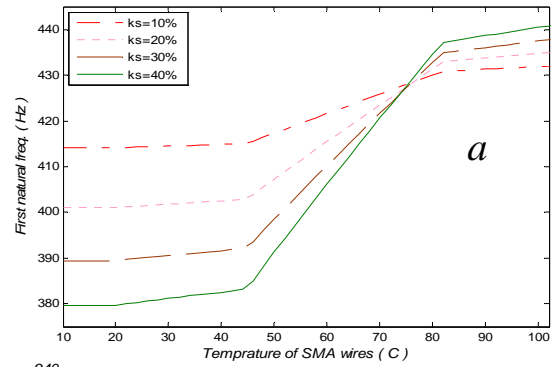

a

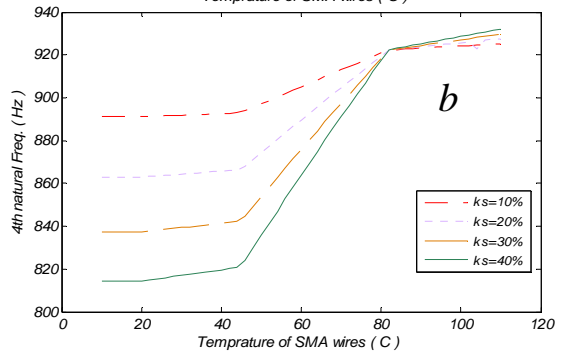

b

( )

SMA

( )

$h_c/h$

( )

) °C

ε₀ = %

(



SMA

( )

$a/b$

$a/h$

%

$a/h$

(%)

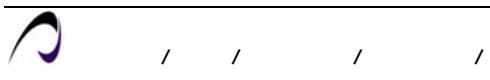
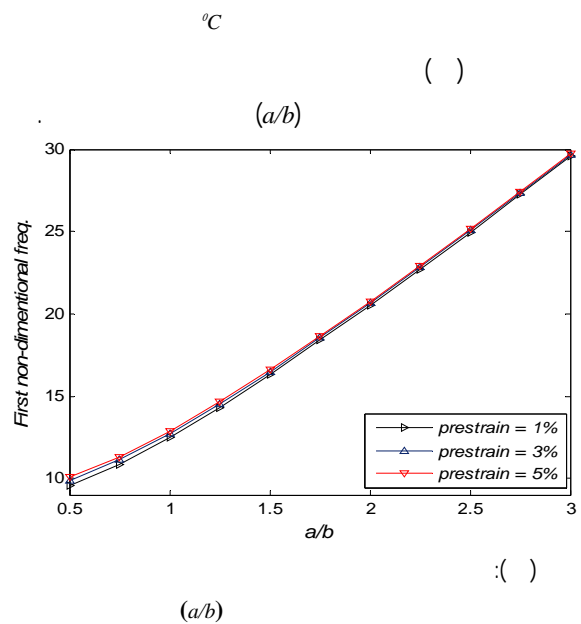
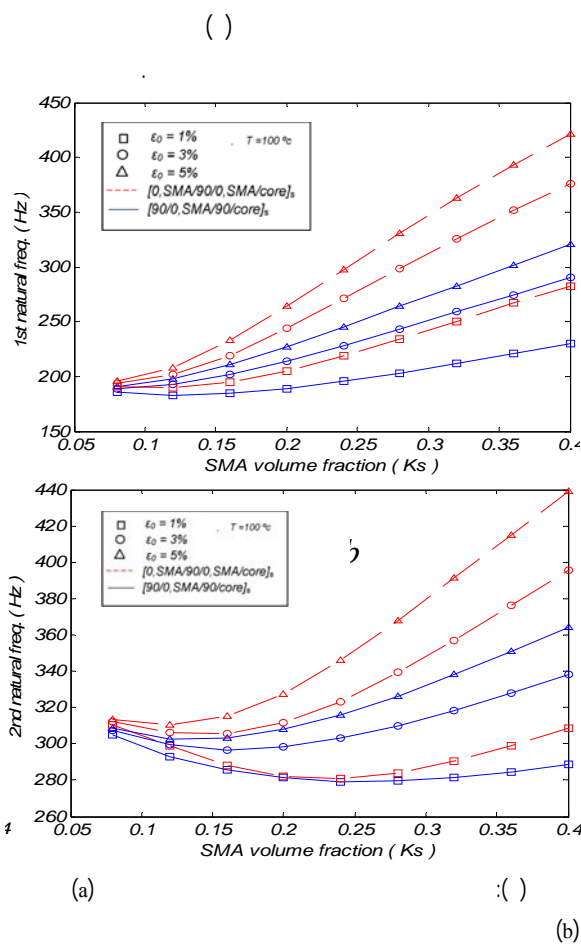
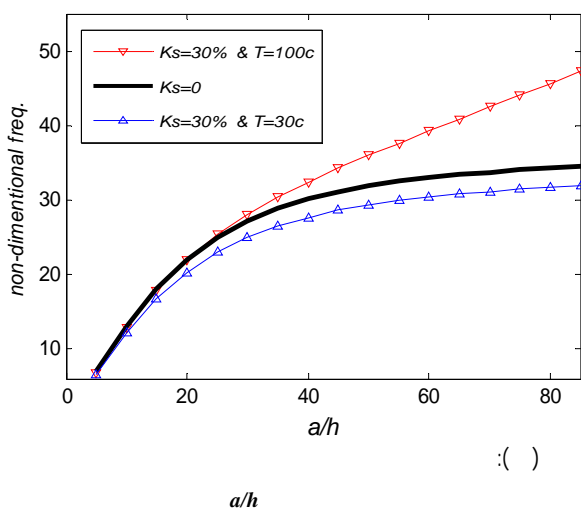

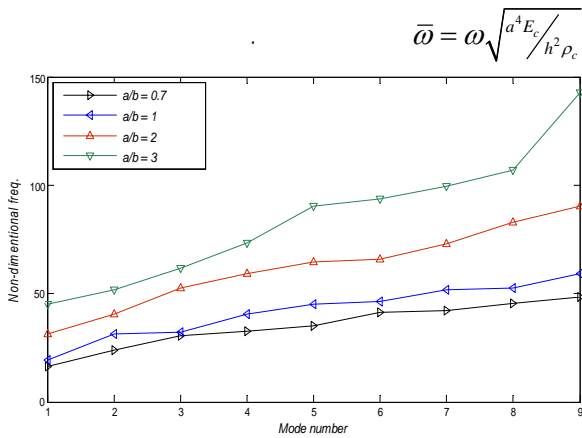

$a/b$  : ( )

( )

SMA

SMA

) SMA

(a/h)

SMA

(a/b)

SMA

$\bar{\omega}_c$   
%  
( $K_s = \% r \cdot$ )

$K_s =$

$a/h$   
( $A_f$ )  $\bar{\omega}_c$

$a/h$

$K_s =$

SMA ( )

SMA

$a/h$

SMA

$a/b = 1$   $hc/h = l$

%  $\bar{\omega}_c$

SMA

%

SMA

$a/h$

$a/h$

( )

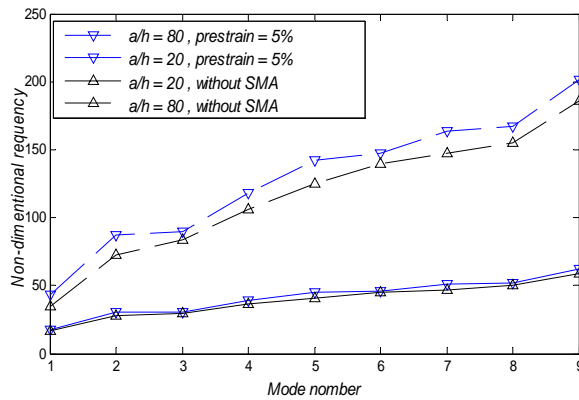

$a/h$

: ( )

( )

$a/h$

$a/b$

Jae-Sang, B.; Park, S.; Hwan, k.; "Vibration of thermally post-buckled composite plates embedded with shape memory alloy fibers", Composite structures, vol. 63, p.p. 179-188, 2004.

[ ]

John, S.; Hariri, M.; "Effect of shape memory alloy actuation on the dynamic response of polymeric composite plates", Composites, applied science and manufacturing: Part A, vol. 39, p.p.769-776, 2008.

[ ]



“  
”  
( )  
Reddy, J.N.; “Energy principles and variational methods in applied Mechanics”, Department of Mechanical Engineering of Texas, A&M University, 2002.  
Rogers, C.A.; Liang, C.; Jia, J.; “Structural modification of simply-supported laminated plates using embedded shape memory alloy fibers”, Composite Structures, Vol. 38, p.p. 569-580, 1999.

[ ] Ostachowicz, W.; Krawczuk, M.; Zak, A.; “Dynamics and Buckling of a multilayer composite plate with embedded SMA wires”, Composite Structures, vol. 48, p.p. 163-167, 2008. [ ]  
Malekzadeh, K.; Kalili, M.R.; Olsson, R.; Jafari, A.; “High-order dynamic response of composite sandwich panels with flexible core under simultaneous low – velocity impact”, International Journal of Solids and Structures, vol. 43, p.p. 6667-6687, 2006. [ ]  
Shih-Yao, K.; Le-chang, S.; Ke-han, C.; “Buckling analysis of shape memory reinforced composite laminates”, Composite structures, vol. 90, p.p. 188-195, 2009. [ ]  
[. Kalili, M.R.; Shokuhfar, A.; Malekzadeh, K.; Ghasemi, F.; “Low-velocity impact response of active thin-walled hybrid composite structures embedded with SMA wires”, Thin-Walled Structures, vol. 45, p.p. 799-808, 2007. [ ]  
Ibrahim, H.H.; HeeYoo,H.; SooLee, K.; “Aero-thermo-mechanical characteristics of imperfect shape memory alloy hybrid composite panels”, Journal of Soundand Vibration, p.p. 230-237, 2010. [ ]

IHSAPT  
FSDT  
Shape Memory Alloy (SMA)  
NiTiNoI  
Martensit  
Austenite  
Recovery stress  
Active Property Tuning (APT)  
Active strain Energy Tuning (ASET)  
Ostachowicz  
Shih yao kou  
in-plane  
Mindlin  
MATLAB  
[90/0,SMA/90/core/90/0,SMA/90]s

