

amehdilo@yahoo.com  
zareh\_h\_1359@yahoo.com  
iranajad@yahoo.com

Zn

Zn % / + % /  
Zn /  
/ Zn  
Zn

## Production Of Zinc Carbonates Concentrate From Angouran Low Grade Zones

### Abstract

With increasing zinc world price, its extraction from Angouran wastes with average grading up to 12% Zn has been considered. The extraction of zinc from low grade feeds by hydrometallurgical methods has been made uneconomically, by increasing of reagents cost and environmental problems. The hydrometallurgical process on zinc concentrate, produced by gravity or flotation methods, can make economically utilization of this resource.

The Mineralogical studies indicated that the calcite and quartz are the main gangue minerals which accompany the smithsonite as the main valuable zinc mineral. The liberation degree of smithsonite was determined 90 microns.

By the jigging tests on -15+1 mm fraction, a concentrate with grading 27.6% Zn and a recovery of 73.5% is obtained. A concentrate of the smithsonite containing 28.2% Zn with a recovery of 68% can be obtained by the shaking table on -1 mm fraction. By the flotation of compound concentrate from gravity separation methods (jig and shaking table), a concentrate with grading 36% Zn and a recovery of 93.6% is obtained. By the combination of jig, shaking table and flotation, a final concentrate containing of 36% Zn and a total recovery of 67% can be obtained.

**Key Words:** smithsonite, Gravity separation, Flotation, liberation degree, Zinc concentrate

( )

( )

( )

( )

(XRF)

(XRD)

(Aldrich)

(Merck)

(Merck)

) 12"×5"

pH

pH

( ×

TD

TA<sup>4</sup>

SA

T<sup>2</sup>

C<sup>1</sup>

•

•

•

•

XRF

pH

XRF

L.O.I	SO <sub>3</sub>	Co <sub>3</sub> O <sub>4</sub>	NiO	CdO	K <sub>2</sub> O	MgO	Fe <sub>2</sub> O <sub>3</sub>	Al <sub>2</sub> O <sub>3</sub>	CaO	SiO <sub>2</sub>	pbO	ZnO	
/	/	/	/	/	/	/	/	/	/	/	/	/	

(XRD)

( )

α

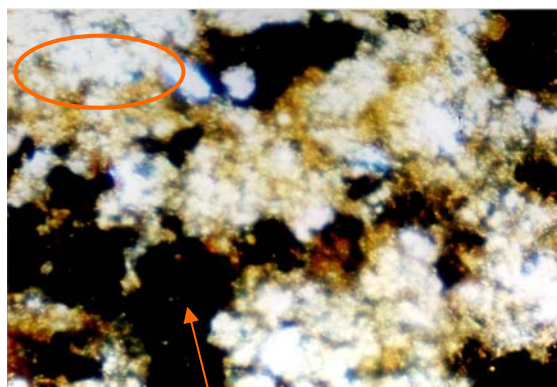
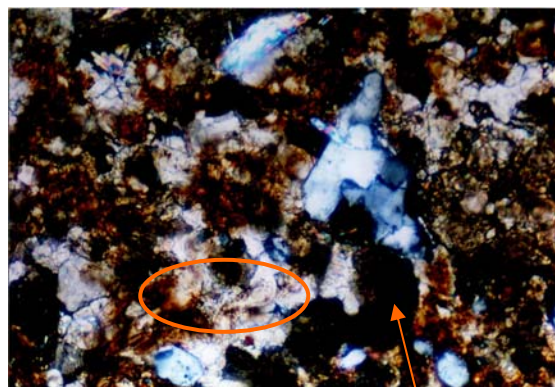

( )

)

)

(

( )

(

d

/

ZnO

ZnO

ZnO

+

ZnO

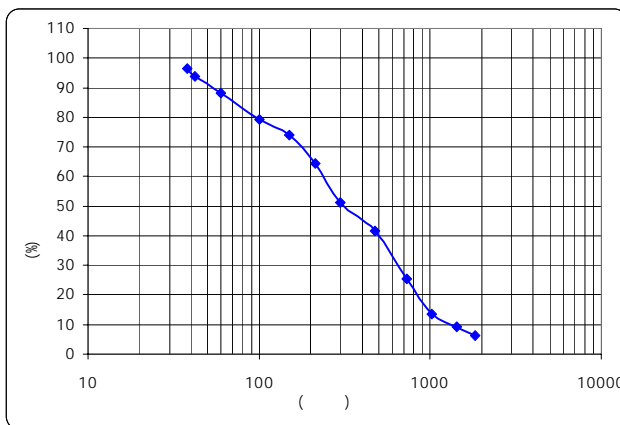
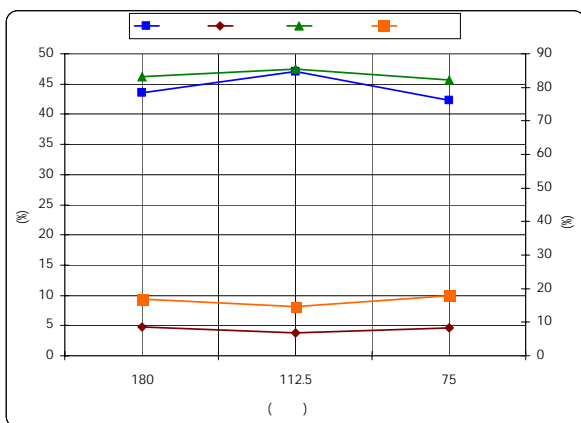
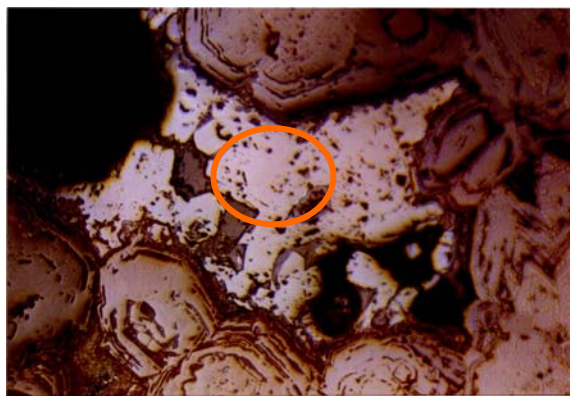
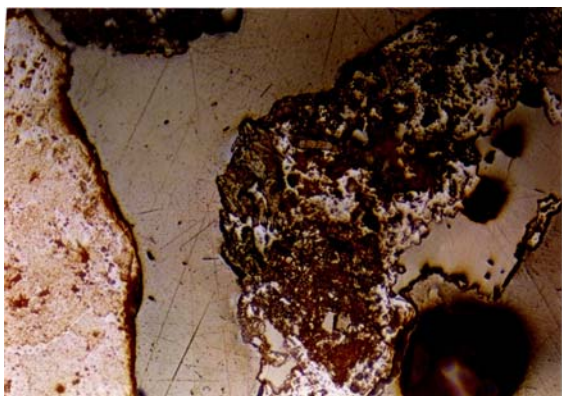

ZnO

d= /

/

/

/

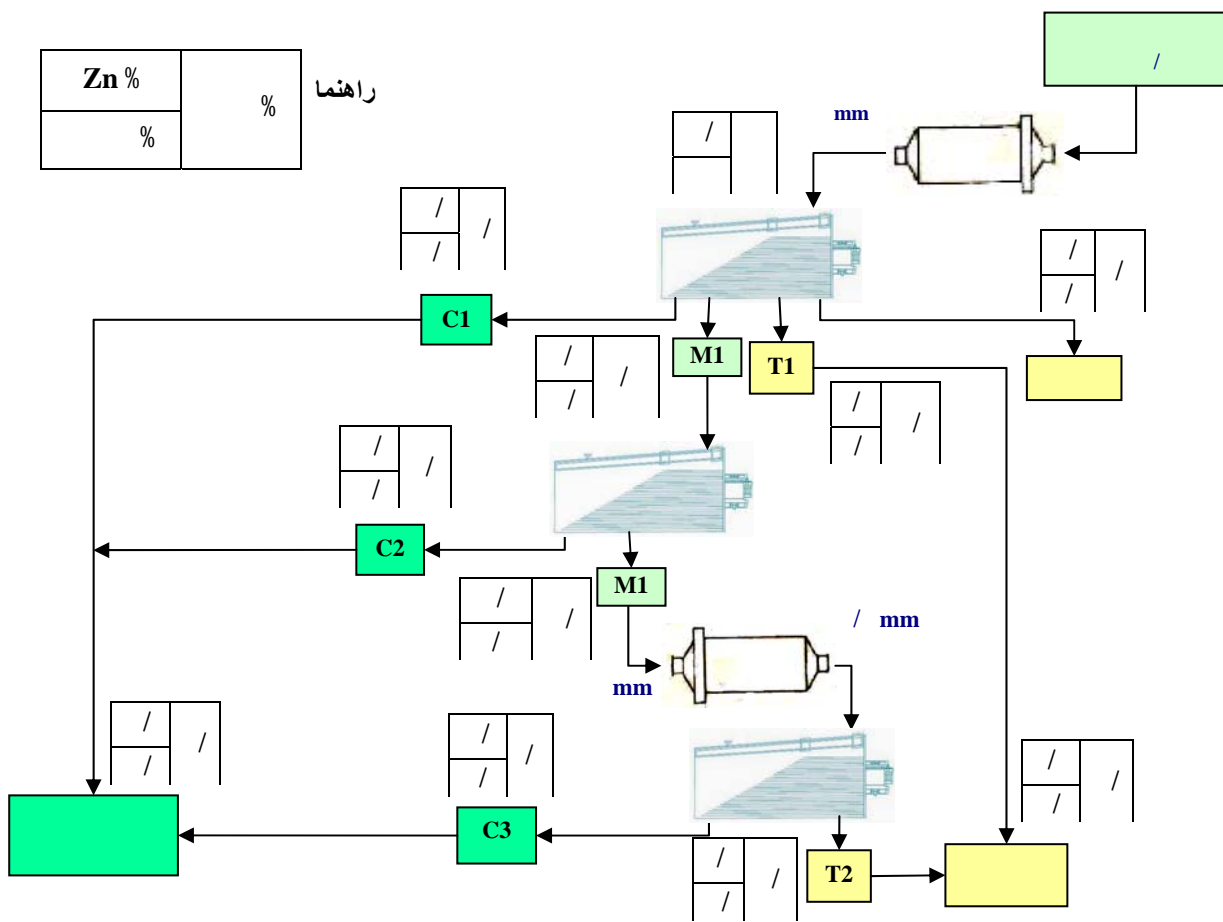

Zn %	%
%	%

راهنما

TD TA SA T C  
C

pH  
pH pH= /

( )

/

/ /

( % / ) ( % )

$d_{80} = 90 \mu\text{m}$

Zn % ( )

( ) % Zn %

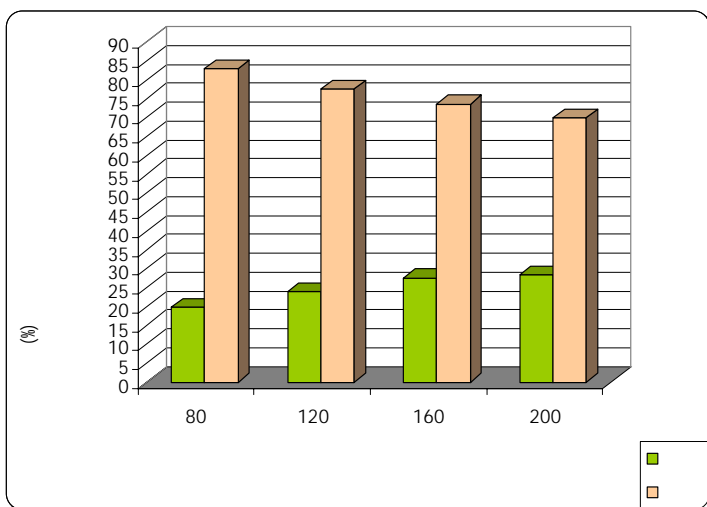

(%)	Zn	(%)			
/	/	/			
/	/	/			
	/				
/	/	/			
/	/	/			
	/				
/	/	/			
/	/	/			
	/				
/	/	/			
	/				

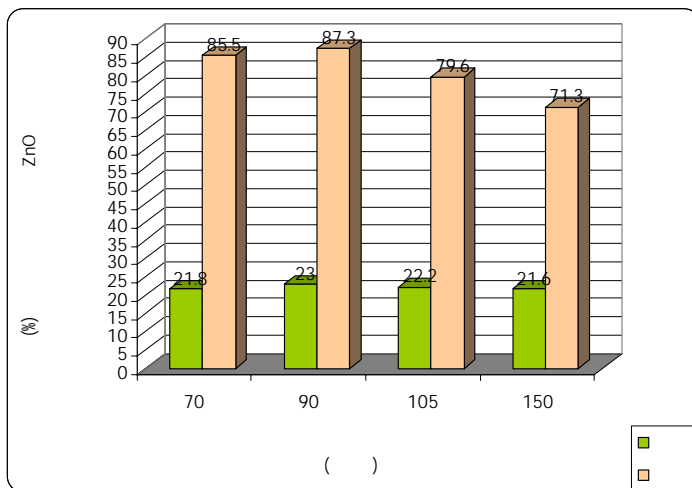

ZnO

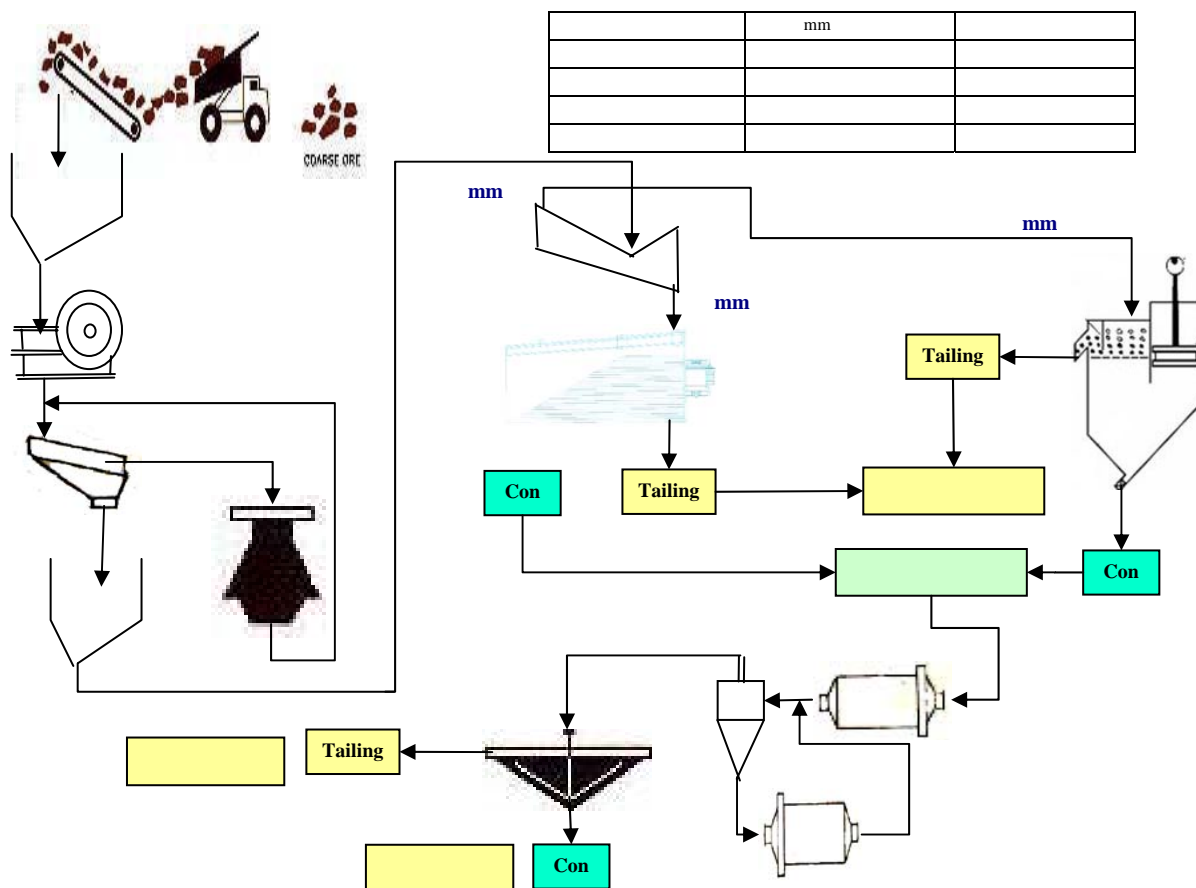



( ) [ ]

- [2] Hosseini S. H. and Forssberg Eric; (2007); "Physicochemical Studies of Smithsonite flotation Using Cationic/Anionic Collectors"; Minerals Engineering; pp.621-624.
- [3] Keqing F.A., Jan Miller D., JIANG Tao, LI Guang-hui; (2005); "*Sulphidization flotation for recovery of lead and zinc from oxide-sulfide ores*"; Transactions of nonferrous metals society of china; Vol.15, No.5, pp.1138-1144.
- [4] Liu Y., Liu Q.; (2004); "*Flotation Separation of Carbonate from Sulfide Minerals, I: flotation of single minerals and minerals mixtures*"; Minerals Engineering; Vol. 17, pp. 855-863.
- [5] Omasundaran p.; (1987); "*Reagents in Mineral Technology*"; New York, Library of Congress Cataloging in Publication Data Reagents in Mineral Technology.
- [6] Onal G., Bulut G., Gul A., Perek K.T., Arslan F.; (2005); "*Flotation of Aladag Oxide Lead-Zinc Ores*"; Minerals Engineering; vol. 18, pp. 279-282.
- [7] Petruk William; (2000); "*Applied Mineralogy in the Mining Industry*"; Elsevier pub..
- [8] Weiss, N.L.; (1985); "*SME Mineral Processing Handbook*"; AIMM, New york.
- [9] Wills, B.A.; (1985); "*Mineral Processing Technology*"; Pergamon press; 3rd edition.

---

<sup>1</sup> - Armac C

<sup>2</sup> - Armac T

<sup>3</sup> - Flotigam SA

<sup>4</sup> - Flotigam TA

<sup>5</sup> - Armeen TD